



**深圳市晶峰达电子科技有限公司**  
ShenZhen JinFengDa Electronic Technology Co., Ltd.  
地址:深圳市龙岗街道 电话:0755-29206918, 13798528768  
网站: www.jfd-ic.com 邮箱: info@jfd-ic.com QQ:402431824

## DL8021 日本电波钟温度时钟 IC

# 产 品 规 格 书

**DL8021**

# 日本電波溫度時鐘

## 一)功能特性:

- 1)工作電壓3.0V,超低電源功耗
- 2)有基本的時間顯示,12/24小時制
- 3)有鬧鐘顯示,5分鐘貪睡時間
- 4)年曆範圍: 2000~2099 (開機顯示2004年)
- 5)雙頻自動追收功能 (40k, 60k)
- 6)邦定選擇RCC接收功能
- 7)邦定選擇溫度功能
- 8)邦定選擇開機攝氏或華氏溫度顯示
- 9)溫度範圍: -9~+70degC  
溫度精確度: +/-1degC  
溫度顯示精度:0.1degC

## 二)液晶顯示圖案

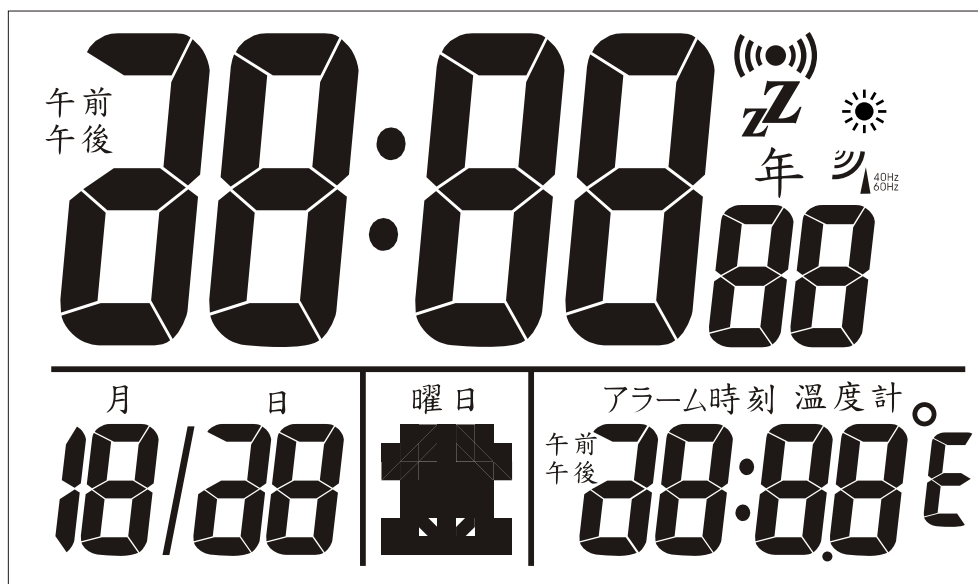

LIGHT/SNZ

MODE/SET

TIME/SET

ALMON/OFF

DOWN  
C/F RCC

UP 12/24

### 三) 流程圖

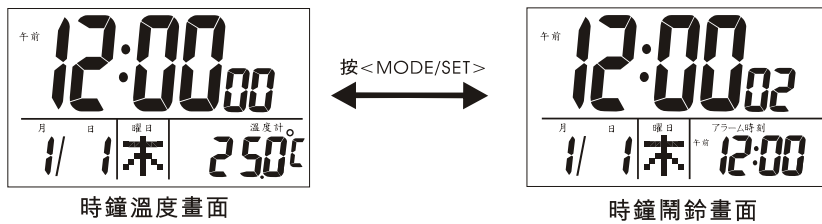

### 四) 操作說明

#### 1) 設定時間和日期

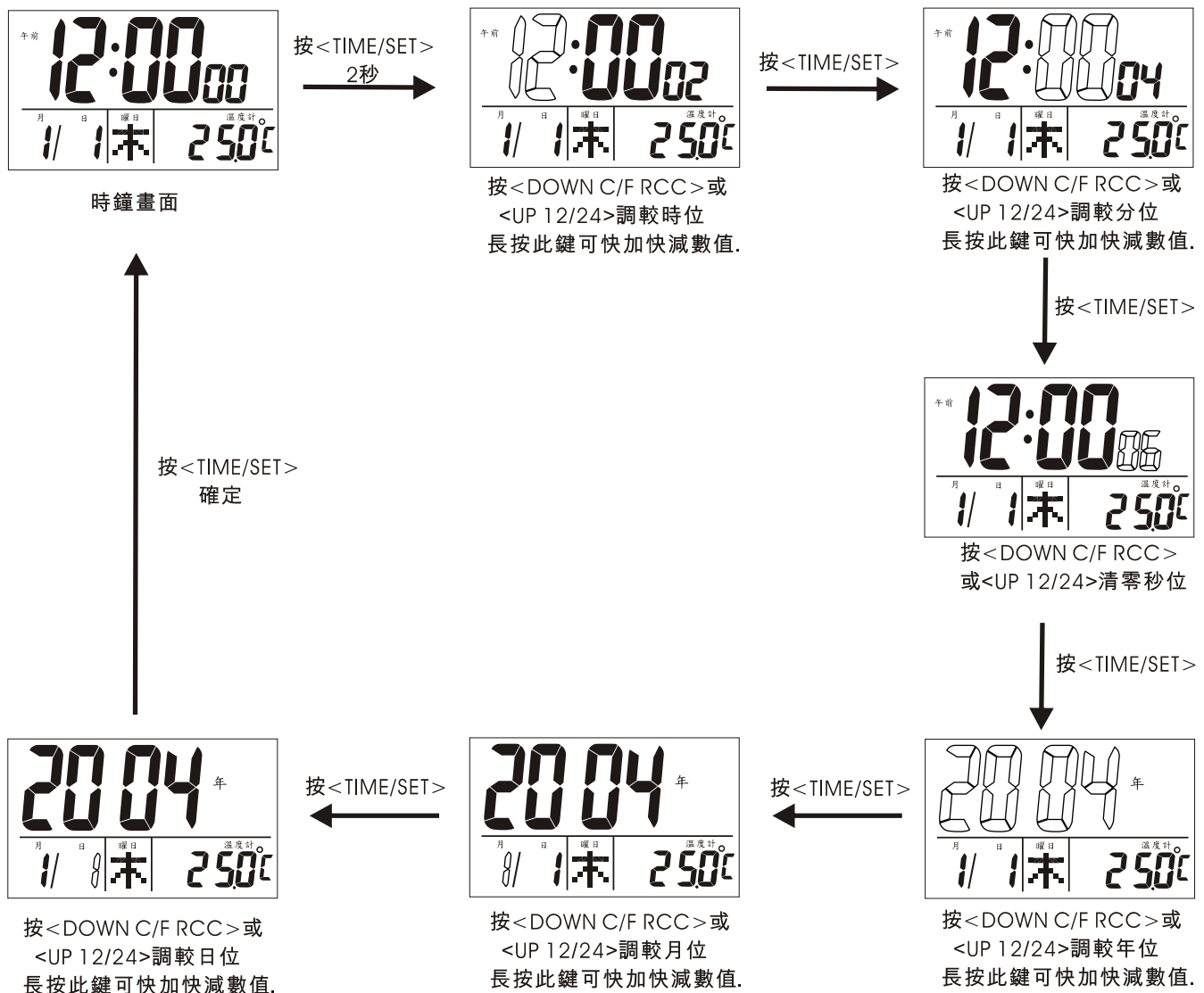

## DL8021

### 2) 設定鬧鐘



### 3) 開關鬧鈴和貪睡功能



### 4) 溫度單位轉換

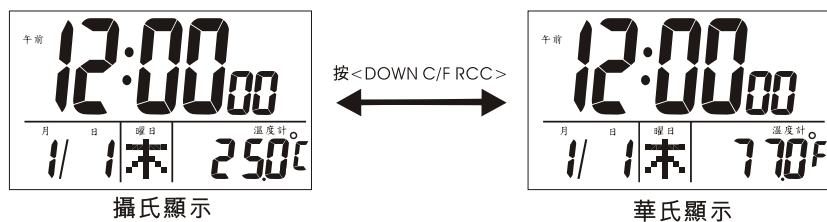

# DL8021

## 5) RCC接收流程圖

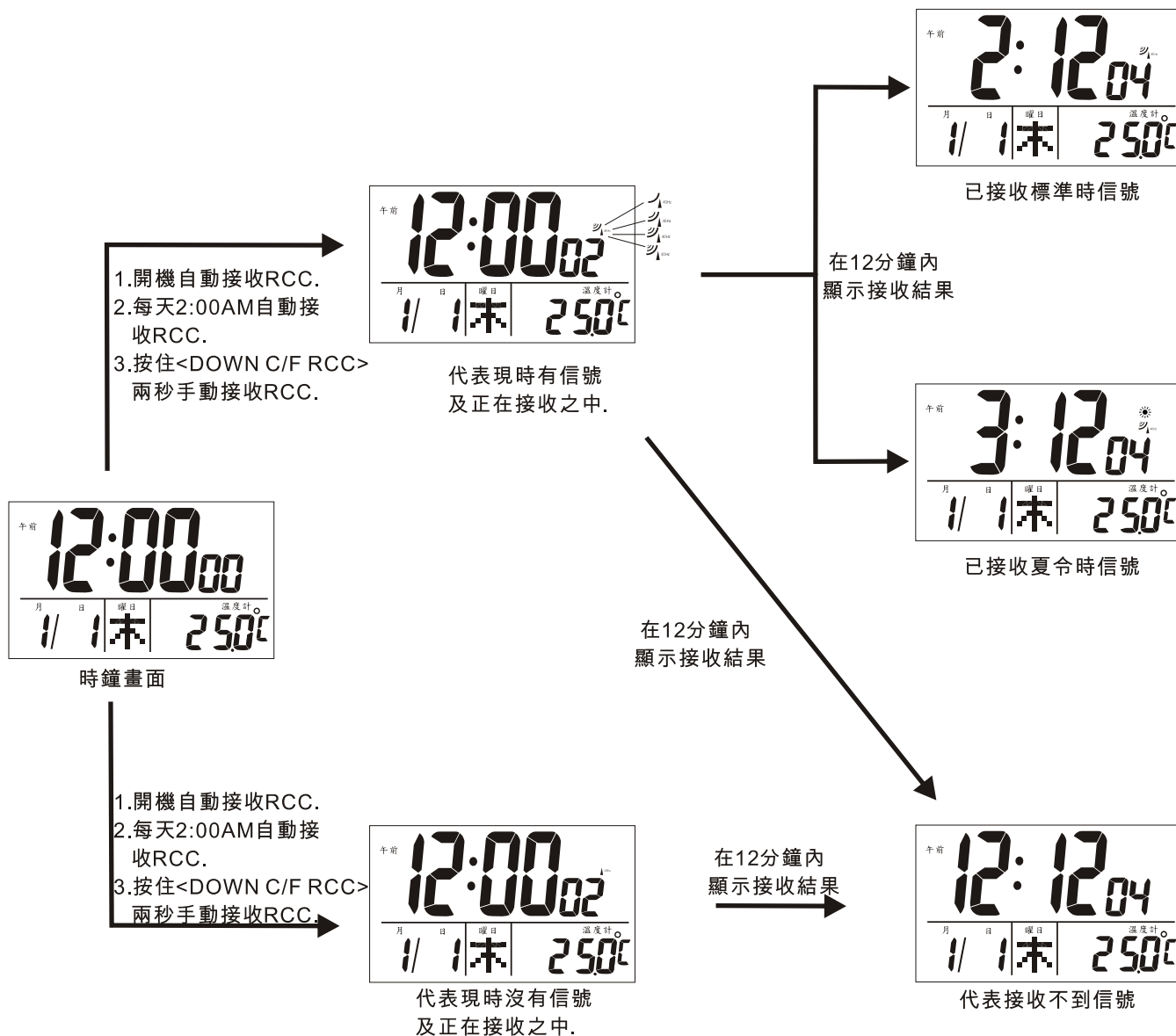

備註:

1. 當接收"RCC"時,除停止接收鍵<DOWN C/F RCC>和<LIGHT/SNZ>外,其他按鍵沒有功能.
2. 若接收不到信號,將於下一小時自動進行追收,共兩次.

# DL8021

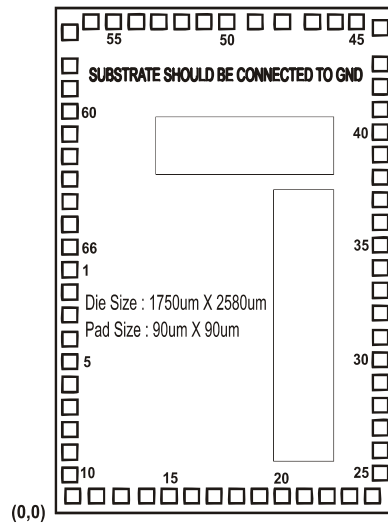

NO	NAME	X	Y	NO	NAME	X	Y
1	BAK	72.5	1229.5	34	SEG12	1677.5	1244.5
2	XIN	72.5	1114.5	35	SEG13	1677.5	1359.5
3	XOUT	72.5	999.5	36	SEG14	1677.5	1474.5
4	N.C.	72.5	884.5	37	SEG15	1677.5	1589.5
5	N.C.	72.5	769.5	38	SEG16	1677.5	1704.5
6	GND	72.5	654.5	39	SEG17	1677.5	1819.5
7	VDD1	72.5	539.5	40	SEG18	1677.5	1934.5
8	VDD2	72.5	424.5	41	SEG19	1677.5	2049.5
9	VDD3	72.5	309.5	42	SEG20	1677.5	2175.0
10	VDD4	72.5	194.5	43	SEG21	1677.5	2300.0
11	N.C.	89.5	72.5	44	SEG22	1677.5	2477.0
12	CUP1	204.5	72.5	45	SEG23	1558.5	2507.5
13	CUP2	319.5	72.5	46	SEG24	1430.45	2507.5
14	COM1	434.5	72.5	47	SEG25	1305.0	2507.5
15	COM2	549.5	72.5	48	SEG26	1164.5	2507.5
16	COM3	669.5	72.5	49	SEG27	1024.0	2507.5
17	COM4	789.5	72.5	50	N.C.	881.5	2507.5
18	COM5	909.5	72.5	51	IOB2	766.5	2507.5
19	COM6	1029.5	72.5	52	IOB3	651.5	2507.5
20	N.C.	1149.5	72.5	53	BZ	536.5	2507.5
21	COM8	1269.5	72.5	54	N.C.	421.5	2507.5
22	N.C.	1389.5	72.5	55	IOC2	306.5	2507.5
23	SEG1	1509.5	72.5	56	IOC3	191.5	2507.5
24	SEG2	1629.5	72.5	57	IOC4	72.5	2477.0
25	SEG3	1677.5	197.5	58	TCO	72.5	2300.0
26	SEG4	1677.5	322.5	59	PON	72.5	2175.0
27	SEG5	1677.5	439.5	60	BAND	72.5	2049.5
28	SEG6	1677.5	554.5	61	N.C.	72.5	1934.5
29	SEG7	1677.5	669.5	62	LIGHT	72.5	1819.5
30	SEG8	1677.5	784.5	63	UNIT	72.5	1704.5
31	SEG9	1677.5	899.5	64	RESET	72.5	1589.5
32	SEG10	1677.5	1014.5	65	INT	72.5	1474.5
33	SEG11	1677.5	1129.5	66	N.C.	72.5	1359.5

**DL8021**

# (Temp+Alm)

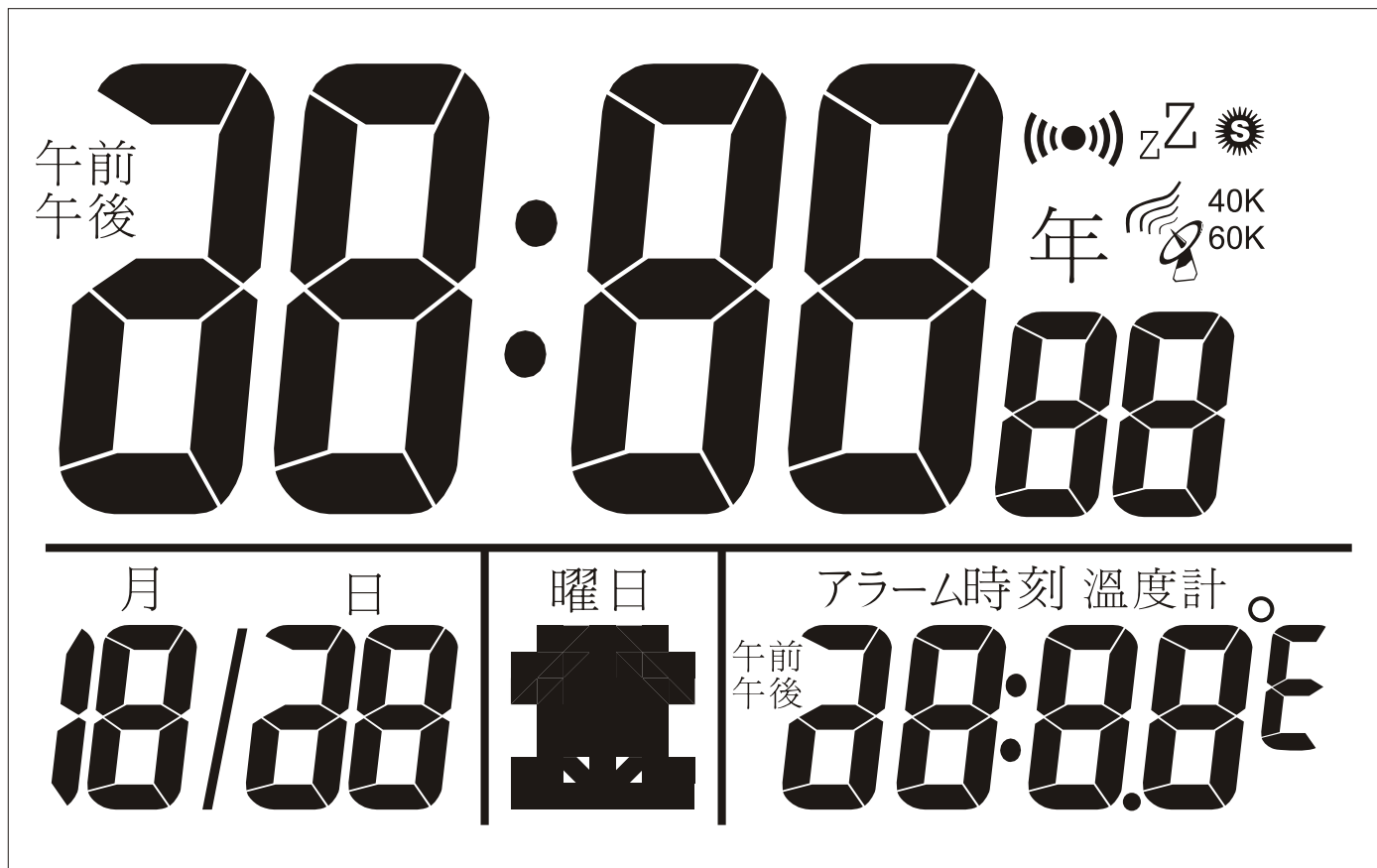

1/6 Duty, 1/3 Bias, 4.5v Vlcd

# DL8021 Temp+Alm)

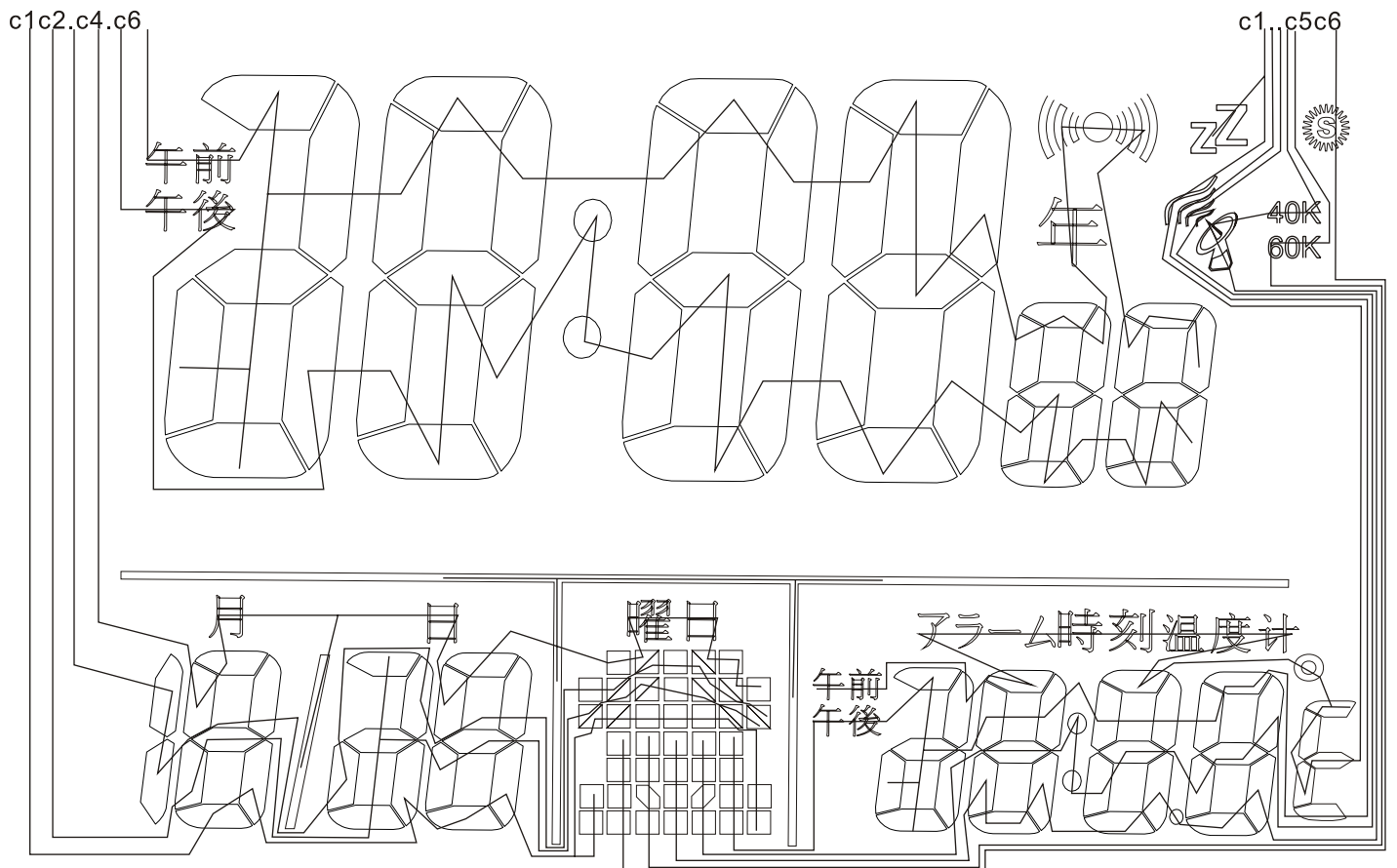
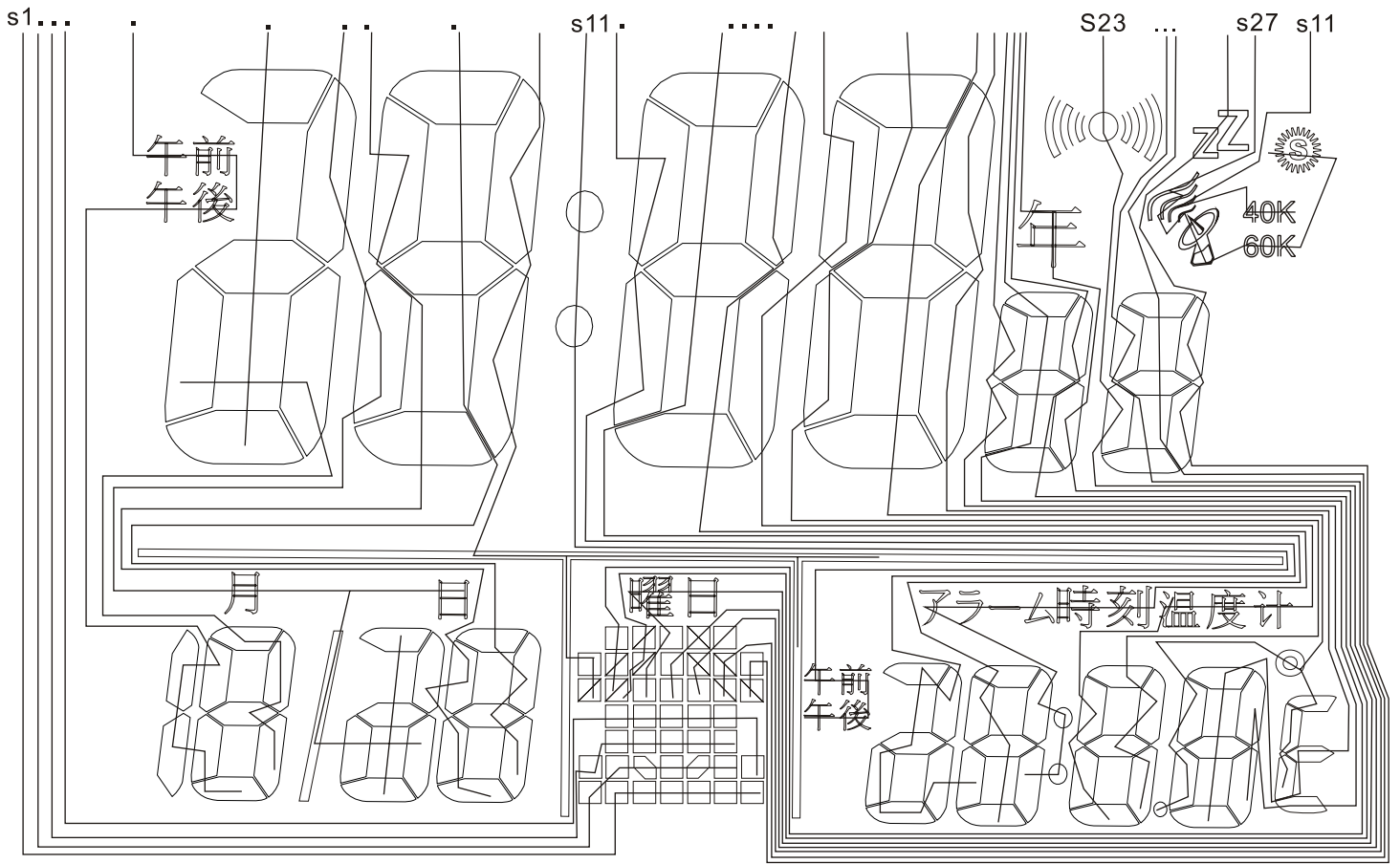



# DL8021 (Alm)

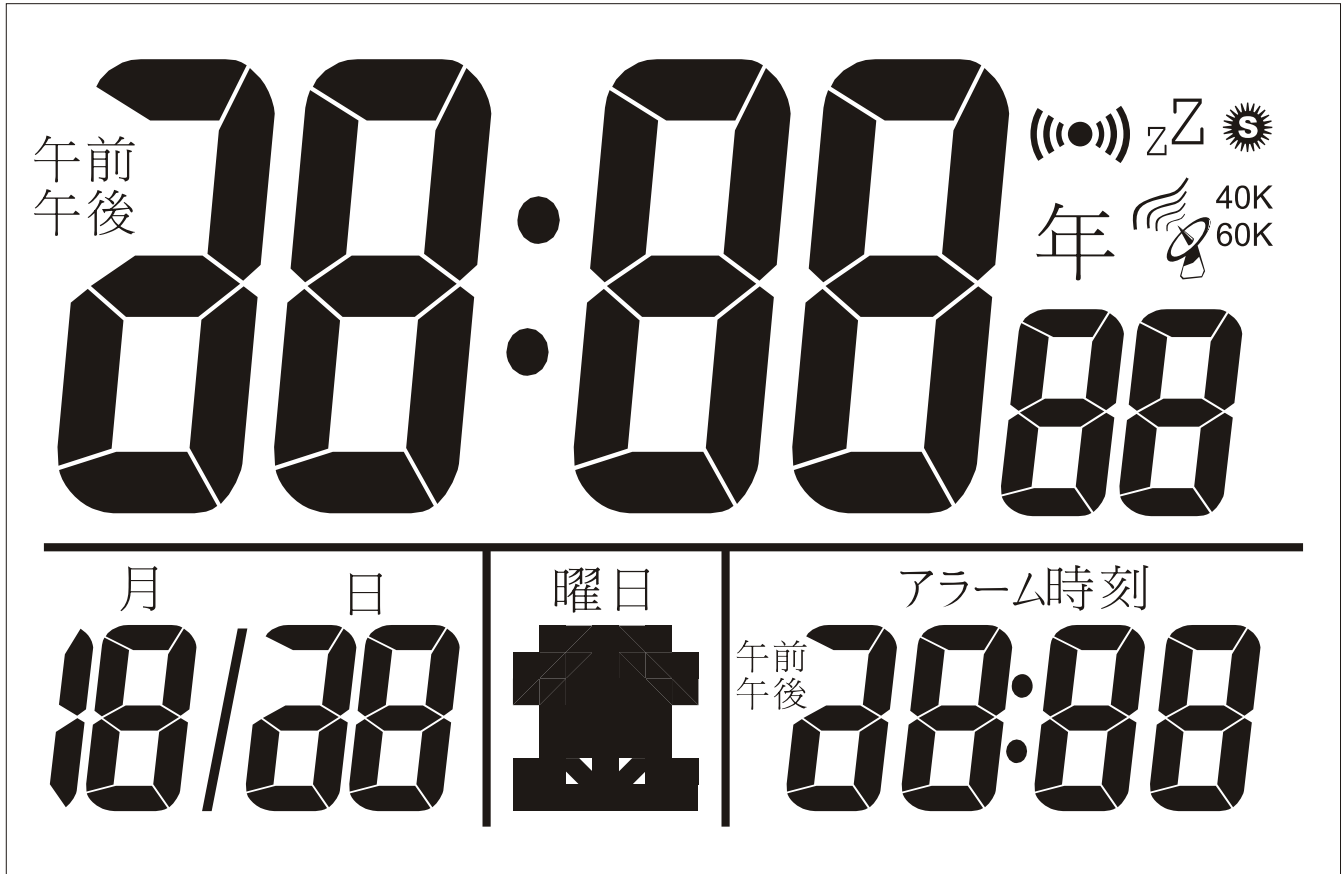

1/6 Duty, 1/3 Bias, 4.5v Vlcd

# DL8021 (Alm)

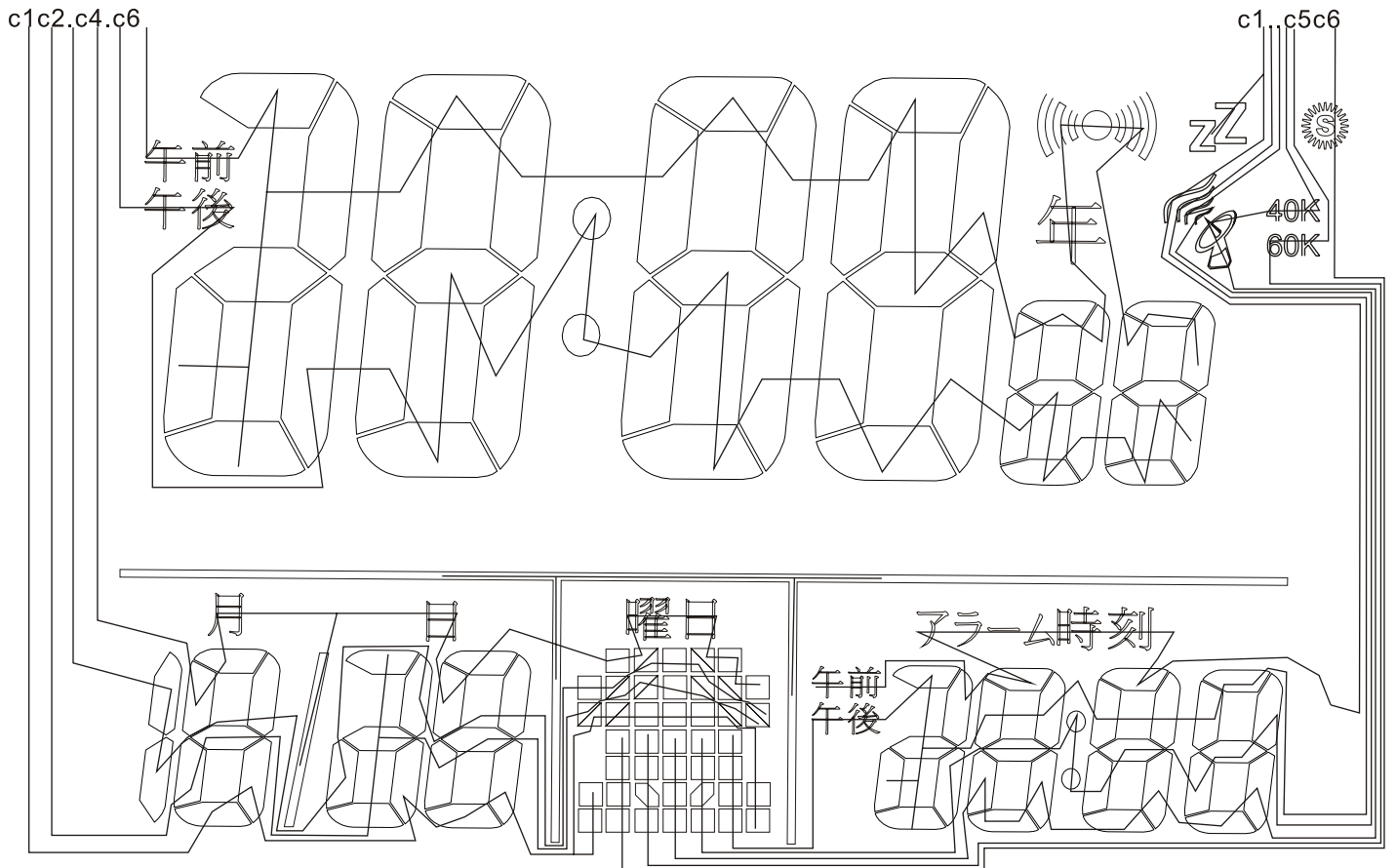
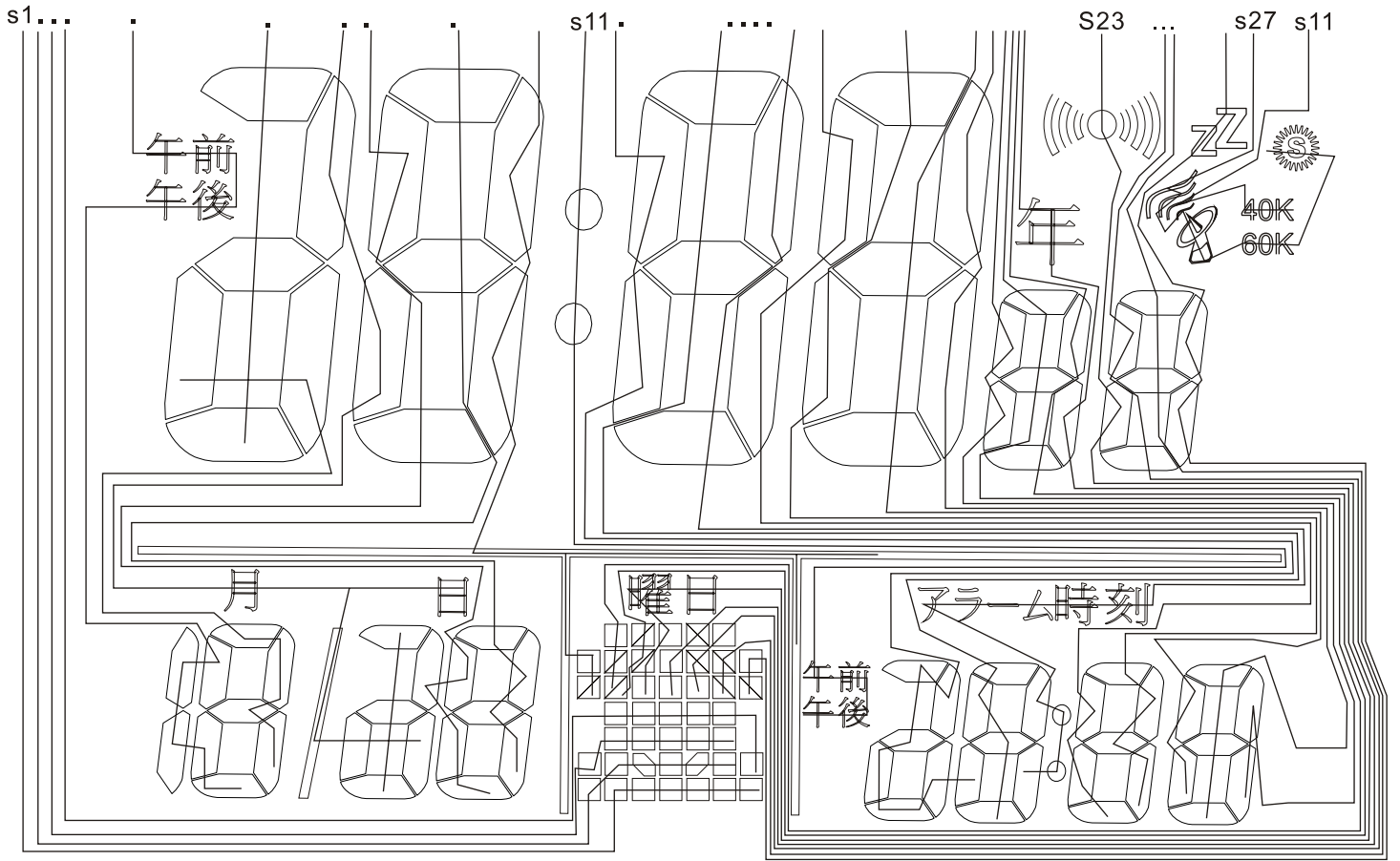

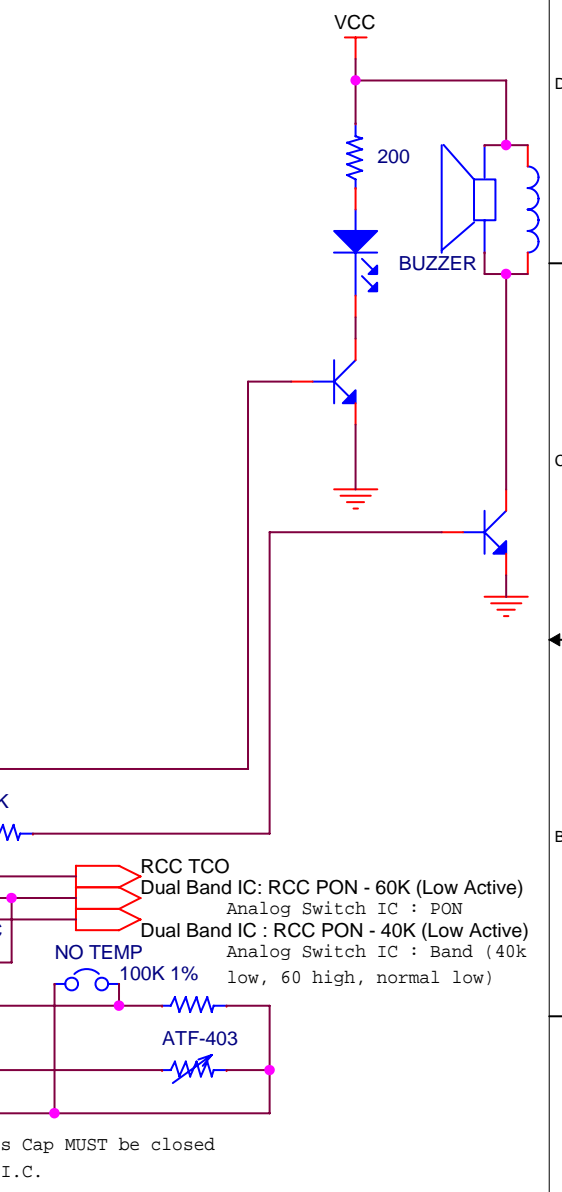
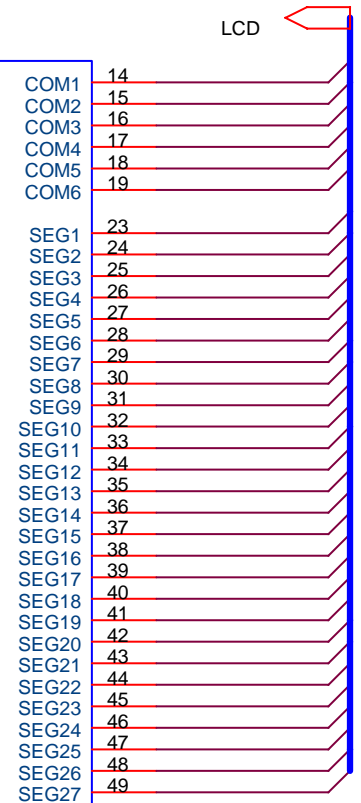
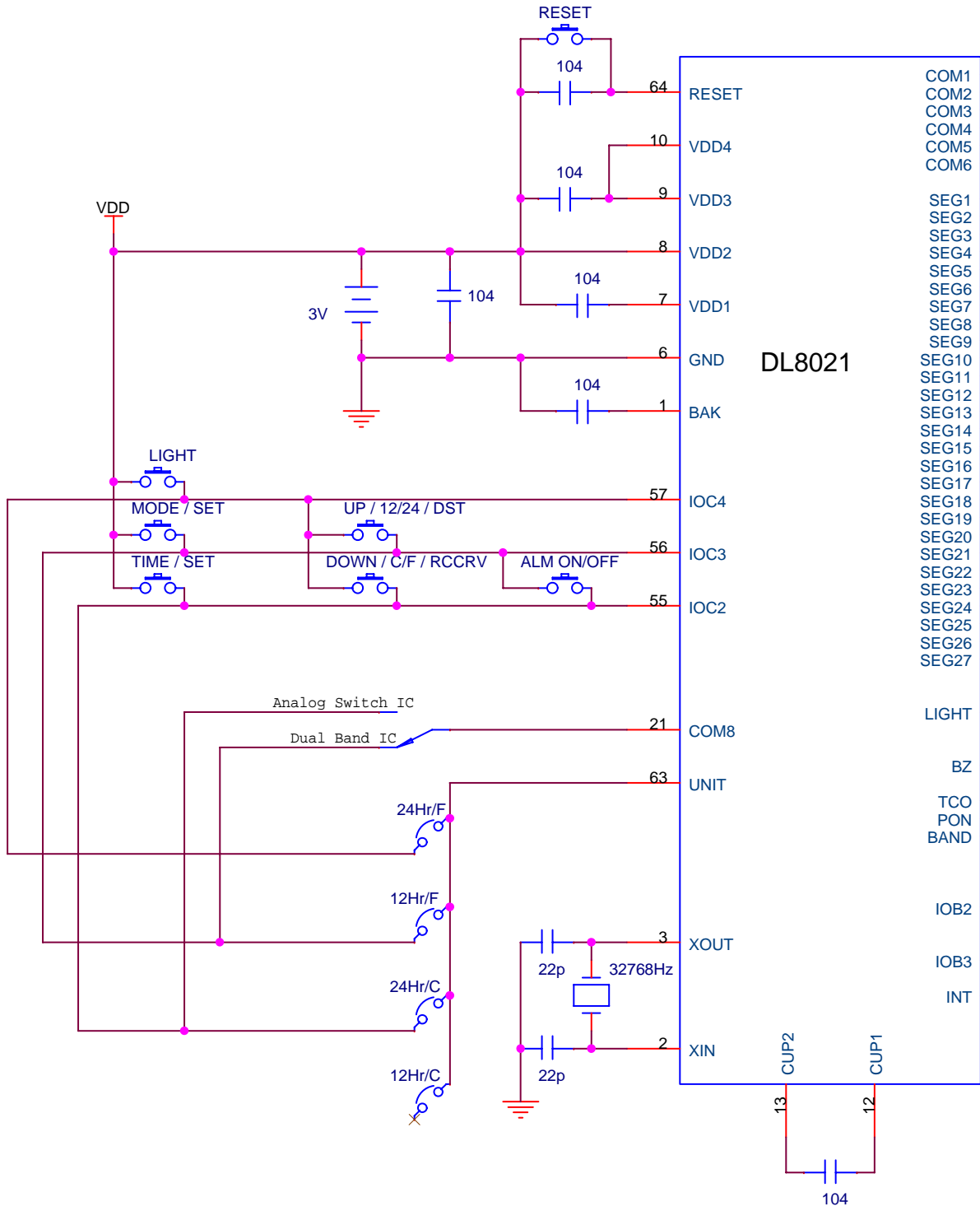

Title		
DL8021		
Size	Document Number	Rev
A		1.3
Date:	Wednesday, January 26, 2005	Sheet 1 of 1